

# CABINS



A photograph of a bedroom interior with light-colored wood paneling on the walls and floor. A bed with a dark headboard and white bedding is visible, along with a wooden bedside table and a framed picture on the wall.

# NATURAL WOOD CABINS

As life changes so do our requirements for extra space. Most of us find ourselves needing extra room for any number of reasons. Be it an extra sleep-out, granny flat, teenage room, home office, art studio, or space at the bach. The applications are limited only by your imagination.

Our natural wood cabins are strong and beautiful. The interior is supplied unfinished for you to choose whatever finish you prefer. We recommend varnishing as the natural golden wood tones can really shine through. The exterior can be painted or stained.

The walls are solid slow-grown Scots Pine. A particularly tough timber well suited to New Zealand's conditions, providing natural insulation. Wall thickness varies from 28mm for the smallest cabins to 36mm for the medium sizes and 47mm for the largest most spacious ones. These generous wall thicknesses clearly set us apart from the competition. All walls fit neatly together in a tongue and groove arrangement ensuring water tightness and durability.

The joinery is all aluminium with 5mm thick toughened glass double glazing. Aluminium joinery is superior to wood, in that it is virtually maintenance free and never needs painting. It also looks fantastic.

The roof is asphalt tiles which look attractive and provide a long lasting and durable finish.

Lifestyle cabins are happy to build your cabin for you using our qualified contractors. This ensures a professional build.

We can also supply your cabin as a flat pack DIY kitset. Full instructions are provided and construction is simple and quick.

All cabins include the foundation framing to ensure your cabin is elevated above ground level.

## Foundations and Site Information

The cabin needs to be completely flat. However this doesn't mean you can't build on a slope. Proper foundations are needed such as piles set in concrete, or a concrete slab. As long as these are perfectly flat you are ready to go. There are other options as well so just give us a call to discuss the best approach for your site.

We are happy to advise on this or complete the work for you, if necessary, for a very reasonable fee. We recommend the floor is a minimum of 50mm off the ground to allow for adequate ventilation. The underside of the flooring is painted and sealed for added protection and weather resistance.

## Features

- Solid Timber construction
- Tongue and groove construction for durability and stability
- Aluminium double-glazed toughened glass doors and windows included
- Doors and windows let in plenty of natural light and fresh air
- Stainless steel hardware
- Roof asphalt shingles included
- Arrives unfinished - choose to stain or paint yours after assembly
- 5 year manufacturer's warranty

## Why are we Better than the Rest?

- Our wall thickness is thicker and hence stronger and better insulating than our competitors.
- Scots pine has better building properties than spruce.
- The windows and doors are aluminium and 5mm double glazed toughened glass. Our competitors are using 3mm glass and wooden frames.
- Our hardware is 304 Stainless steel which will not rust
- Asphalt shingles are supplied as standard.
- Our pitched roofs are higher 2.7m instead of 2.3m
- Buy the best and buy once!



# Kowhai

## Solid Wood Cabin

7 x 4m | 28m<sup>2</sup>

### Specifications

Colour	Natural
Material	Slow-Grown Scots Pine
Product Dimensions	(L) 7 × (W) 4 × (H) 2.835m
Gross weight	2600kg
Side Wall Height	2.43m
Floor Area	28m <sup>2</sup>
Roof Thickness	18mm
Floor Thickness	18mm
Wall Thickness	47mm
Floor Beam	47 x 143mm
Roof Material	waterproof asphalt shingles
Package Contents	roof, roof beams, walls, floor, floor beam, doors, windows, asphalt shingles, lock & keys, instructions

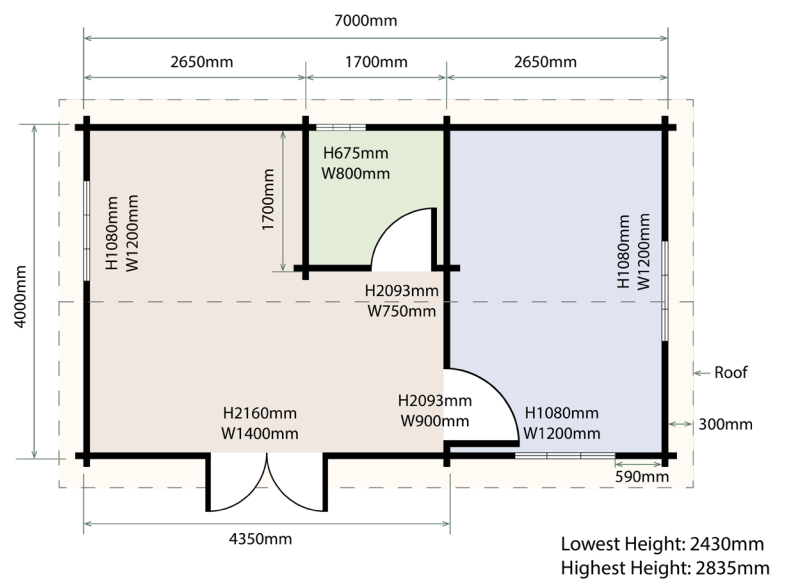

# Woodside Solid Wood Cabin

6 x 4m | 24m<sup>2</sup>



## Specifications

Colour	Natural
Material	Slow-Grown Scots Pine
Product Dimensions	(L) 6 × (W) 4 × (H) 2.835m
Gross weight	2450kg
Side Wall Height	2.16m
Floor Area	24m <sup>2</sup>
Roof Thickness	18mm
Floor Thickness	18mm
Wall Thickness	47mm
Floor Beam	47 x 143mm
Roof Material	waterproof asphalt shingles
Package Contents	roof, roof beams, walls, floor, floor beams, doors, windows, asphalt shingles, lock & keys, instructions

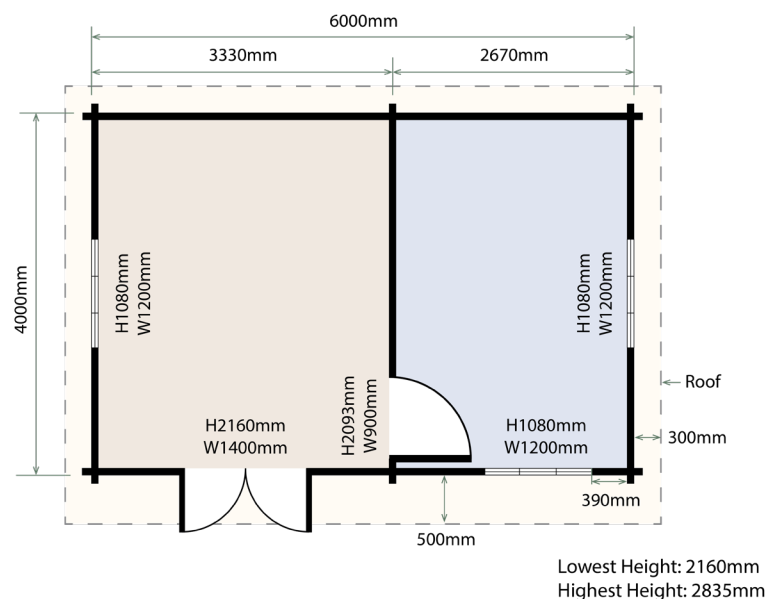

# Pineview

## Solid Wood Cabin

5.3 x 3.8m | 20.14m<sup>2</sup>

### Specifications

Colour	Natural
Material	Slow-Grown Scots Pine
Product Dimensions	(L) 5.3 × (W) 3.8 × (H) 2.7m
Gross weight	2080kg
Side Wall Height	2.16m
Floor Area	20.14m <sup>2</sup>
Roof Thickness	18mm
Floor Thickness	18mm
Wall Thickness	47mm
Floor Beam	47 x 143mm
Roof Material	waterproof asphalt shingles
Package Contents	roof, roof beams, walls, floor, floor beams, doors, windows, asphalt shingles, lock & keys, instructions

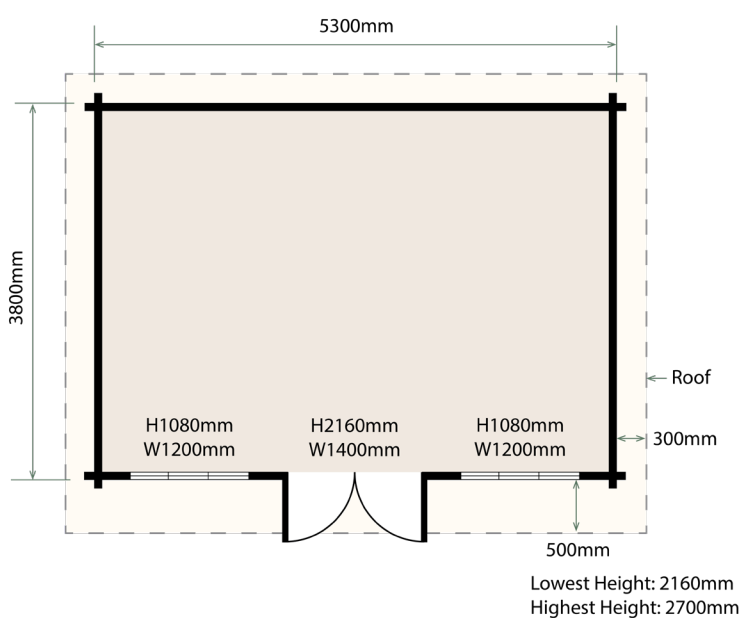

# Evergreen Solid Wood Cabin

4.5 x 3.3m | 14.85m<sup>2</sup>



## Specifications

Colour	Natural
Material	Slow-Grown Scots Pine
Product Dimensions	(L) 4.5 × (W) 3.3 × (H) 2.7m
Gross weight	1730kg
Side Wall Height	2.16m
Floor Area	14.85m <sup>2</sup>
Roof Thickness	18mm
Floor Thickness	18mm
Wall Thickness	47mm
Floor Beam	47 x 143mm
Roof Material	waterproof asphalt shingles
Package Contents	roof, roof beams, walls, floor, floor beams, doors, windows, asphalt shingles, lock & keys, instructions

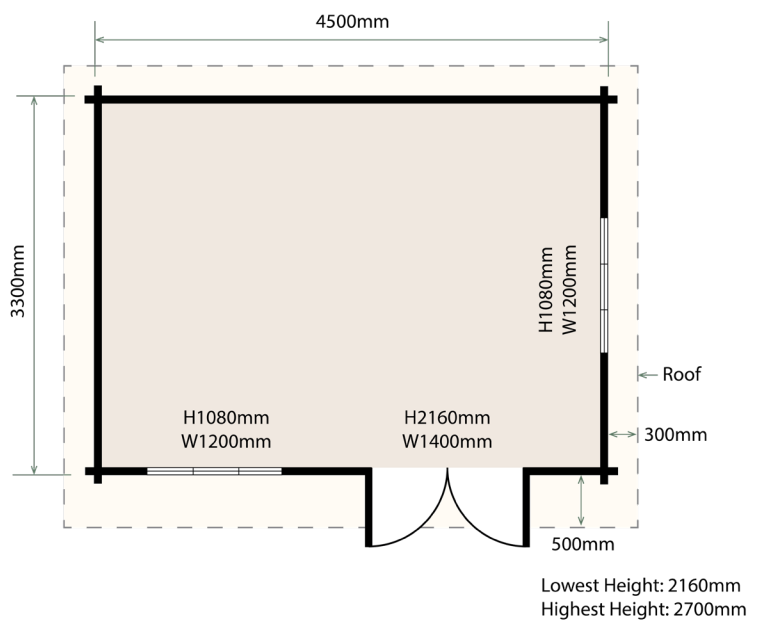

# Meadow

## Solid Wood Cabin

3.6 x 3m | 10.8m<sup>2</sup>

### Specifications

Colour	Natural
Material	Slow-Grown Scots Pine
Product Dimensions	(L) 3.6 × (W) 3 × (H) 2.835m
Gross weight	1200kg
Side Wall Height	2.363m
Floor Area	10.8m <sup>2</sup>
Roof Thickness	18mm
Floor Thickness	18mm
Wall Thickness	36mm
Floor Beam	38 x 45mm
Roof Material	waterproof asphalt shingles
Package Contents	roof, roof beams, walls, floor, floor beams, doors, windows, asphalt shingles, lock & keys, instructions

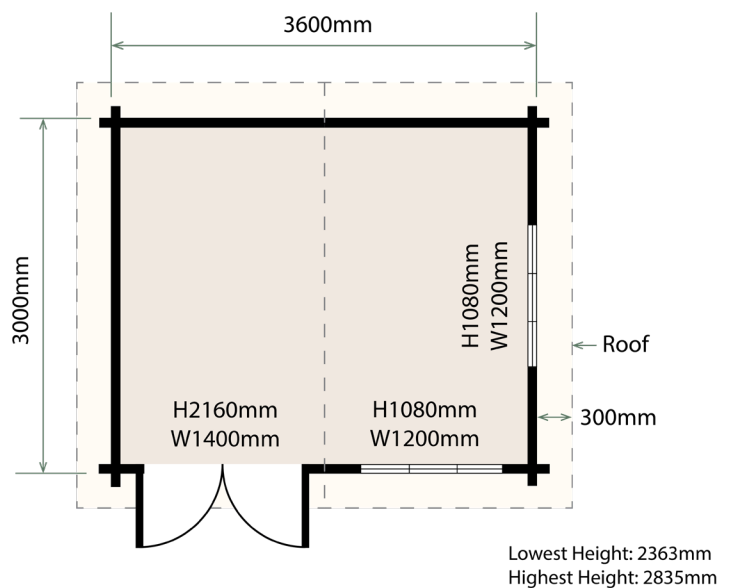



# Grove

## Solid Wood Cabin

2.8 x 2.8m | 7.84m<sup>2</sup>



### Specifications

Colour	Natural
Material	Slow-Grown Scots Pine
Product Dimensions	(L) 2.8 × (W) 2.8 × (H) 2.835m
Gross weight	850kg
Side Wall Height	2.363m
Floor Area	7.84m <sup>2</sup>
Roof Thickness	18mm
Floor Thickness	18mm
Wall Thickness	28mm
Floor Beam	38 x 45mm
Roof Material	waterproof asphalt shingles
Package Contents	roof, roof beams, walls, floor, floor beams, doors, asphalt shingles, lock & keys, instructions

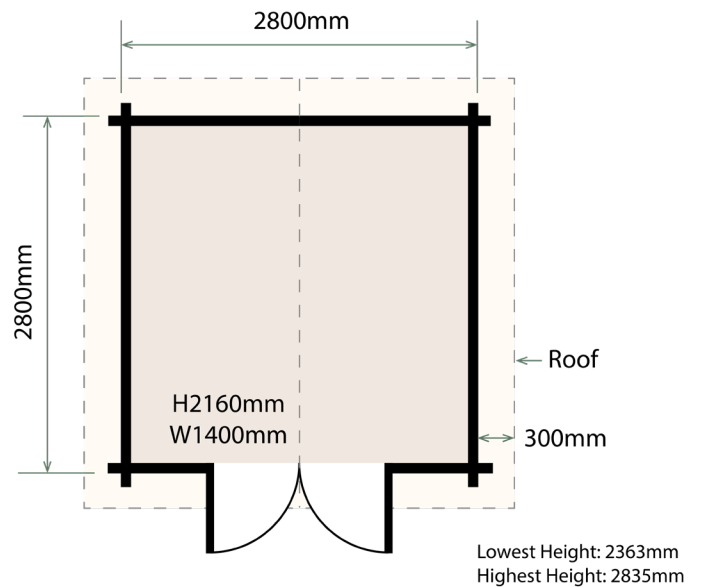

# Suggested Interior Floor Plans



Kowhai Solid Wood Cabin: 7 x 4m



Woodside Solid Wood Cabin: 6 x 4m



Pineview Solid Wood Cabin: 5.3 x 3.8m

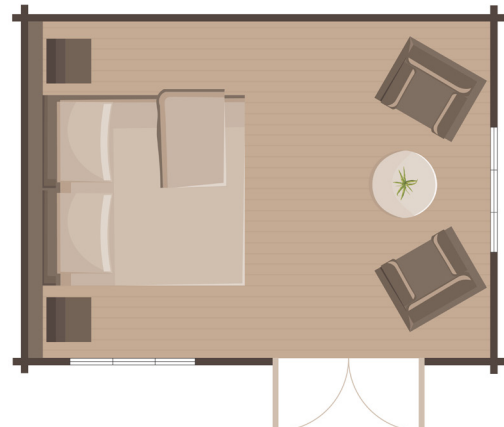

Evergreen Solid Wood Cabin: 4.5 x 3.3m

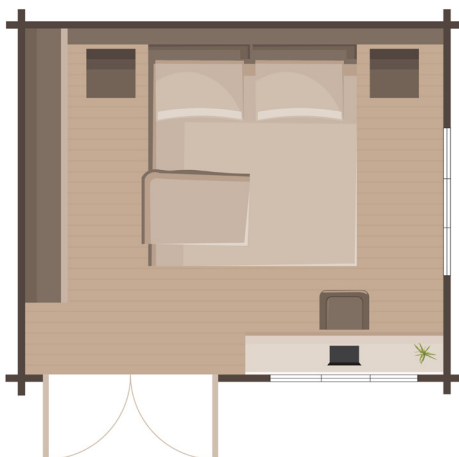

Meadow Solid Wood Cabin: 3.6 x 3m



Grove Solid Wood Cabin: 2.8 x 2.8m